

technical data

Semco® specialty application nozzles

Semco® rivet nozzles are used to apply the required amount of sealant into the countersink and through hole prior to fastening parts with rivets.

The assorted sizes are color coded for easy identification.

The rivet nozzle is designed for use with materials packaged in Semco® cartridges or Semkit® packages and applied with Semco® model 250 pneumatic guns. The spring-loaded tip of the rivet nozzle acts as a check valve allowing precise shots of material to be dispensed.

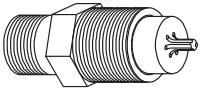
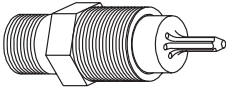
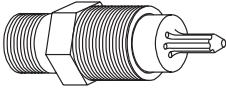
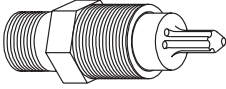
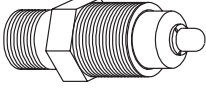
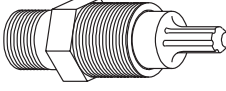
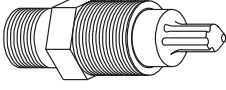
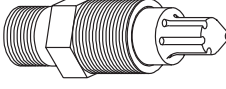
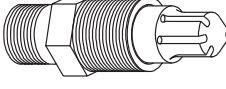
		Part number	Color	Fits hole size	Size and quantity of dispensing holes
	3/32"	234285	Germaine green	3/32"	.030" dia., 6 ea. equally spaced
	1/8"	226837	Blue	1/8"	.031" dia., 6 ea. equally spaced
	5/32"	226838	Black	5/32"	.035" dia., 6 ea. equally spaced
	3/16"	226839	White	3/16"	.060" dia., 6 ea. equally spaced
	3/16"-120°	234260*	Green	3/16"-120°	.030" dia., 6 ea. equally spaced
	7/32"	234284	Light blue	7/32"	.046" dia., 6 ea. equally spaced
	1/4"	226840	Red	1/4"	.044" dia., 6 ea. equally spaced
	5/16"	233051	Orange	5/16"	.062" dia., 6 ea. equally spaced
	3/8"	233052	Yellow	3/8"	.062" dia., 6 ea. equally spaced

**All rivet nozzles are equipped with threads to fit into Semco® cartridges.
*P/N 234260 applies sealant to countersink only.**

Semco® rivet nozzles

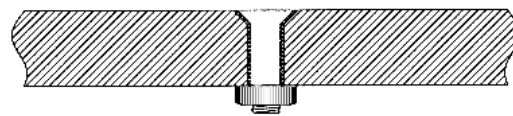
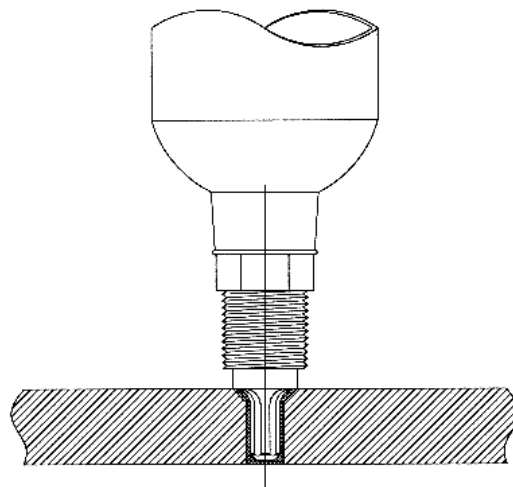
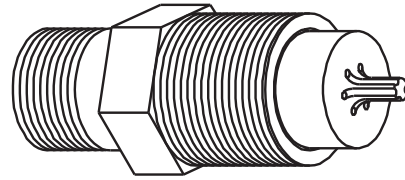

Semco and Semkit are trademarks of PRC-DeSoto International, Inc., registered with the U.S. Patent Office.

All recommendations, statements, and technical data contained herein are based on tests we believe to be reliable and correct, but accuracy and completeness of said tests are not guaranteed and are not to be construed as a warranty, either expressed or implied. User shall rely on his own information and tests to determine suitability of the product for the intended use and assumes all risks and liability resulting from his use of the product. Seller's and manufacturer's sole responsibility shall be to replace that portion of the product of this manufacturer which proves to be defective. Neither seller nor manufacturer shall be liable to the buyer or any third person for any injury, loss, or damage directly or indirectly resulting from use of, or inability to use, the product. Recommendations or statements other than those contained in a written agreement signed by an officer of the manufacturer shall not be binding upon the manufacturer or seller.